

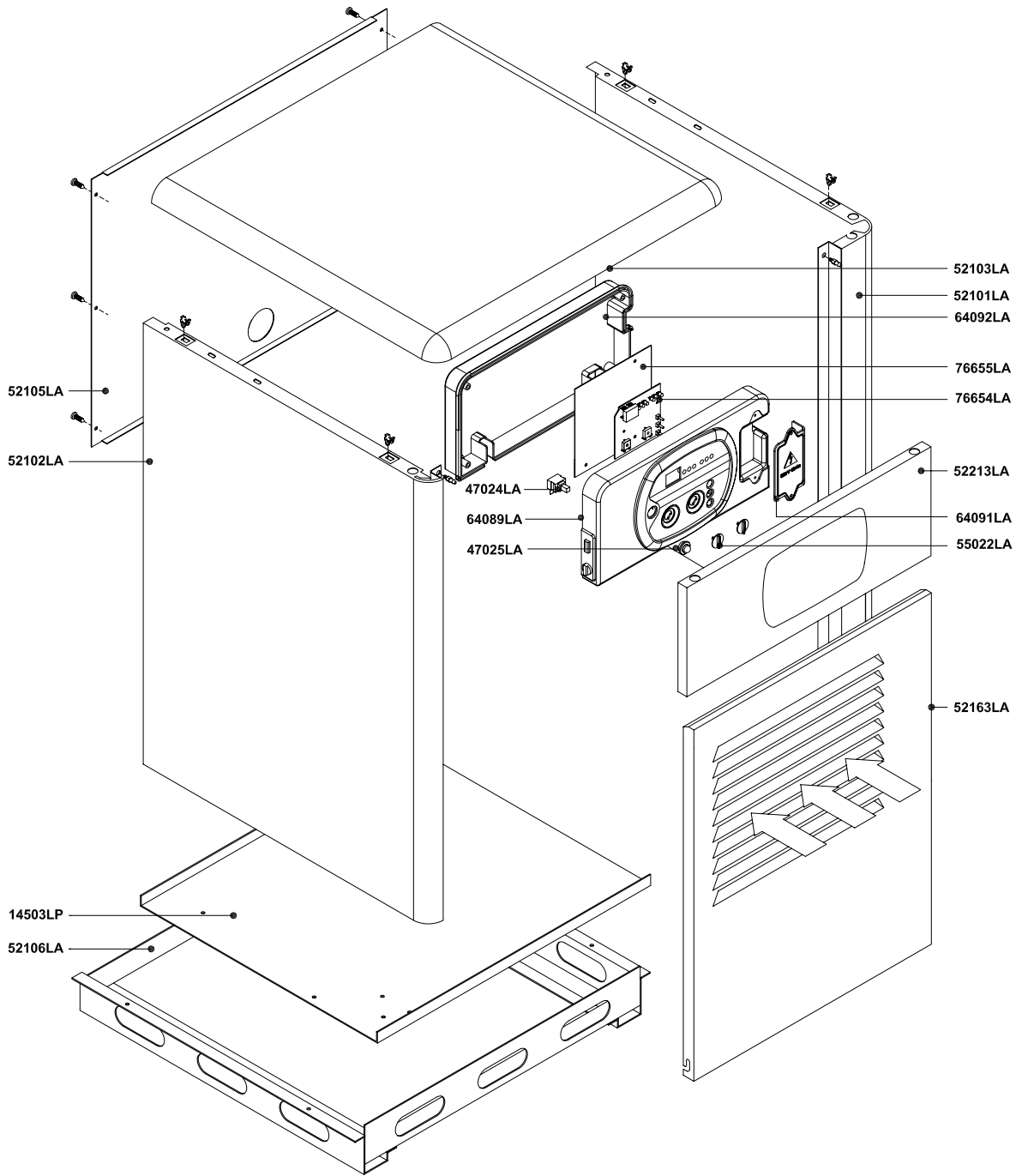

Rev.	Description	Date
------	-------------	------

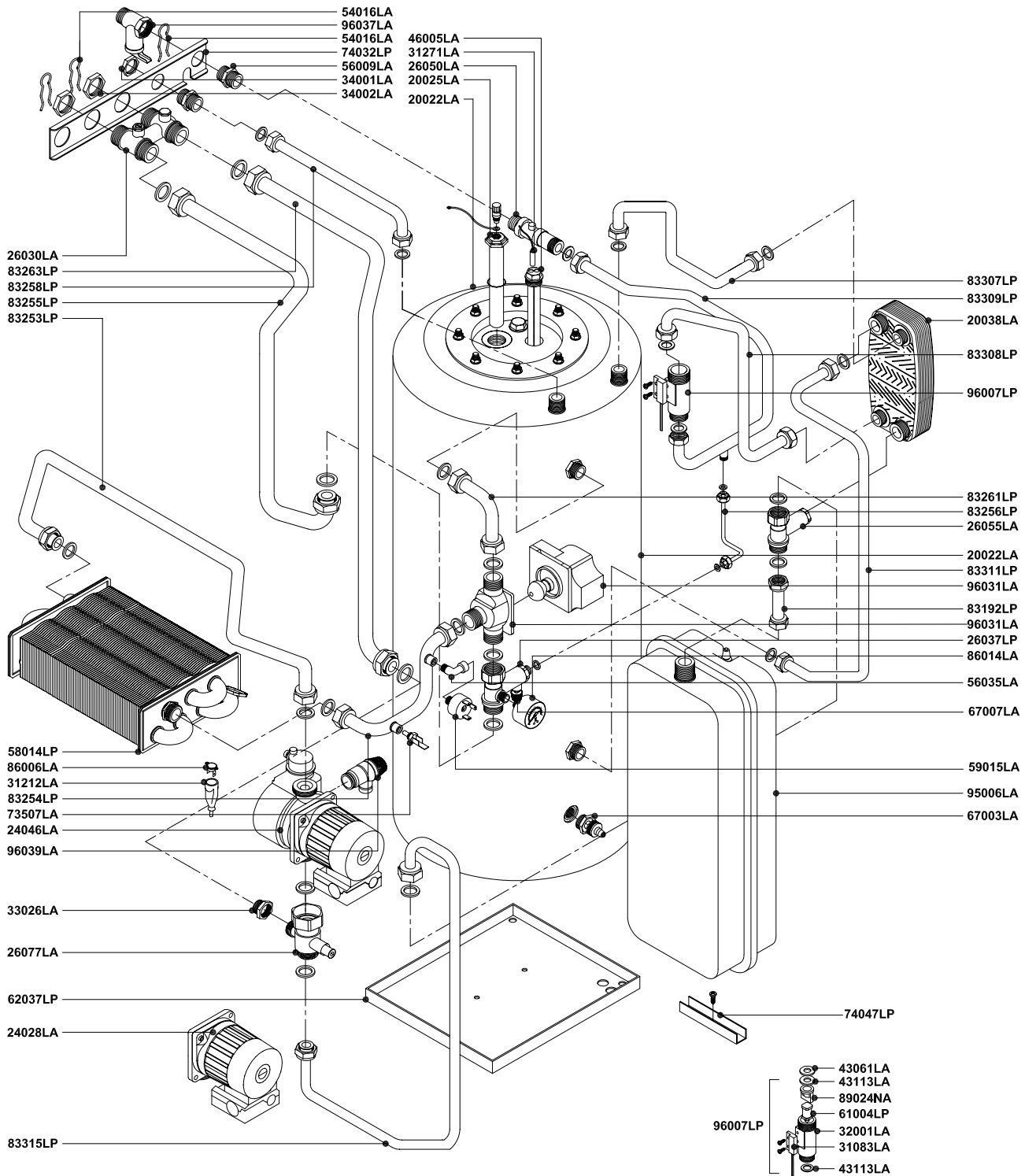

 RADIANT BRUCIATORI S.p.A.	Pos.	Code	Description:	Date: 15.09.2004	A992A411B351	U.M.	Qt.
			Description: Wall hung boiler - with D.H.W. storage cylinder spare parts FRAME + CASING COMPONENTS Object / model: mod. RBA 24 E Open combustion chamber - electronic ignition	Scale: --	A992B411B351		methane L.P.G. heavy oil
				Department: tecnico	Code no.:		
				Designed by:			
				Controlled by:			
				Approved by:	Sheet no.:	B0355_AE1	
<small>ALL DESCRIPTIONS AND ILLUSTRATIONS CONTAINED IN THIS LEAFLET HAVE BEEN CAREFULLY PREPARED BUT WE RESERVE THE RIGHT TO MAKE CHANGES AND IMPROVEMENTS IN OUR PRODUCTS WHICH MAY AFFECT THE ACCURACY OF THE INFORMATION CONTAINED IN THIS LEAFLET, E + 0E ALL RIGHTS RESERVED. NO PART OF THIS DOCUMENT MAY BE REPRODUCED, SAVED IN STORAGE SYSTEMS OR TRANSMITTED IN ANY FORM OR BY ANY MEANS, WHETHER ELECTRONIC, MECHANICAL, PHOTOCOPIING, RECORDING OR OTHERS, WITHOUT THE MANUFACTURERS PRIOR AUTHORISATION IN WRITING.</small>							

Rev.	Description	Date
------	-------------	------



 RADIANT BRUCIATORI S.p.A.	Pos.	Code	Description:	Date:	15.02.2005	U.M.	A992A411B351	Qt.	methane
	Description:			Scale:	---		A992B411B351		L.P.G.
	Wall hung boiler - with D.H.W. storage cylinder spare parts			Department:	tecnico				
	HYDRAULIC SYSTEM			Designed by:					heavy oil
	Object / model:			Controlled by:					
mod. RBA 24 E			Approved by:						
open combustion chamber - electronic ignition			Sheet no.:		B0356_AE2				

ALL DESCRIPTIONS AND ILLUSTRATIONS CONTAINED IN THIS LEAFLET HAVE BEEN CAREFULLY PREPARED BUT WE RESERVE THE RIGHT TO MAKE CHANGES AND IMPROVEMENTS IN OUR PRODUCTS WHICH MAY AFFECT THE ACCURACY OF THE INFORMATION CONTAINED IN THIS LEAFLET, E + OE ALL RIGHTS RESERVED. NO PART OF THIS DOCUMENT MAY BE REPRODUCED, SAVED IN STORAGE SYSTEMS OR TRANSMITTED IN ANY FORM OR BY ANY MEANS, WHETHER ELECTRONIC, MECHANICAL, PHOTOCOPIING, RECORDING OR OTHERS, WITHOUT THE MANUFACTURER'S PRIOR AUTHORIZATION IN WRITING.

Rev.	Description	Date
------	-------------	------

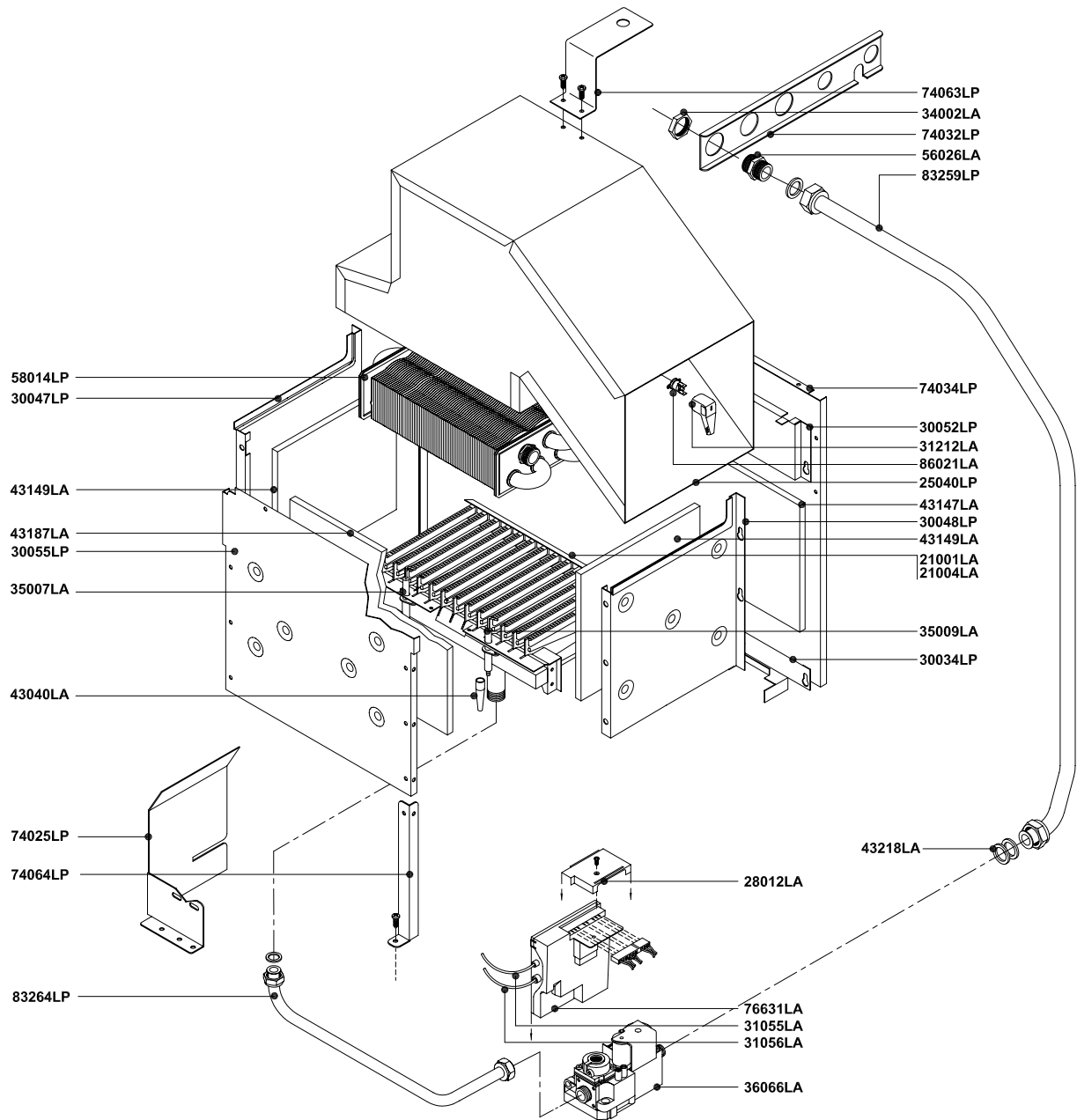

Pos.	Code	Description:		U.M.	Qt.
		Description:	Date: 15.09.2004	A992A411B351	methane
		Wall hung boiler - with D.H.W. storage cylinder spare parts	Scale: --	A992B411B351	L.P.G.
		THERMAL SYSTEM	Department: tecnico		
		Object / model:	Designed by:		heavy oil
		mod. RBA 24 E	Controlled by:		
		<i>room sealed - electronic ignition</i>	Approved by:	Sheet no.:	B0357_AE1
<small>ALL DESCRIPTIONS AND ILLUSTRATIONS CONTAINED IN THIS LEAFLET HAVE BEEN CAREFULLY PREPARED BUT WE RESERVE THE RIGHT TO MAKE CHANGES AND IMPROVEMENTS IN OUR PRODUCTS WHICH MAY AFFECT THE ACCURACY OF THE INFORMATION CONTAINED IN THIS LEAFLET, E + OE ALL RIGHTS RESERVED. NO PART OF THIS DOCUMENT MAY BE REPRODUCED, SAVED IN STORAGE SYSTEMS OR TRANSMITTED IN ANY FORM OR BY ANY MEANS, WHETHER ELECTRONIC, MECHANICAL, PHOTOCOPIING, RECORDING OR OTHERS, WITHOUT THE MANUFACTURERS PRIOR AUTHORISATION IN WRITING.</small>					



RADIANT BRUCIATORI S.p.A.

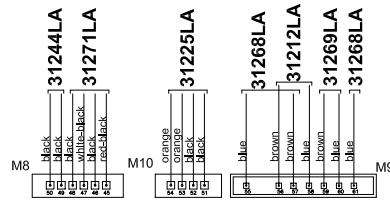

MAIN PRINTED CIRC. BOARD CVI-M SM 20015 COD. 76655LA

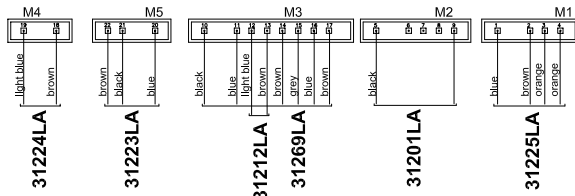
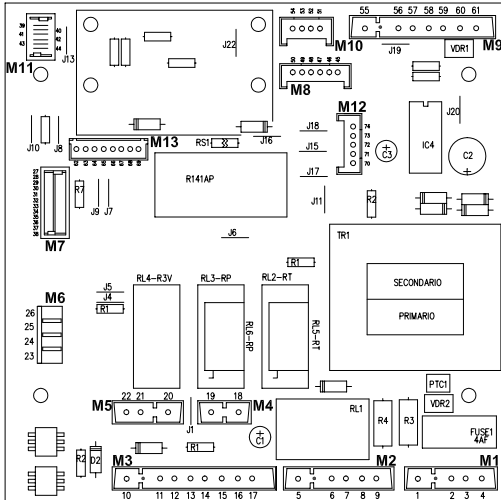

**DISPLAY DIGITAL BOARD 2000 SKO6206
76654LA**

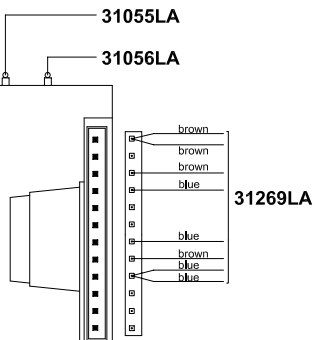
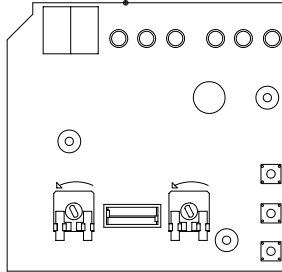

**ELECTRONIC IGNITION BOARD
S4565QM1012 code 76631LA**

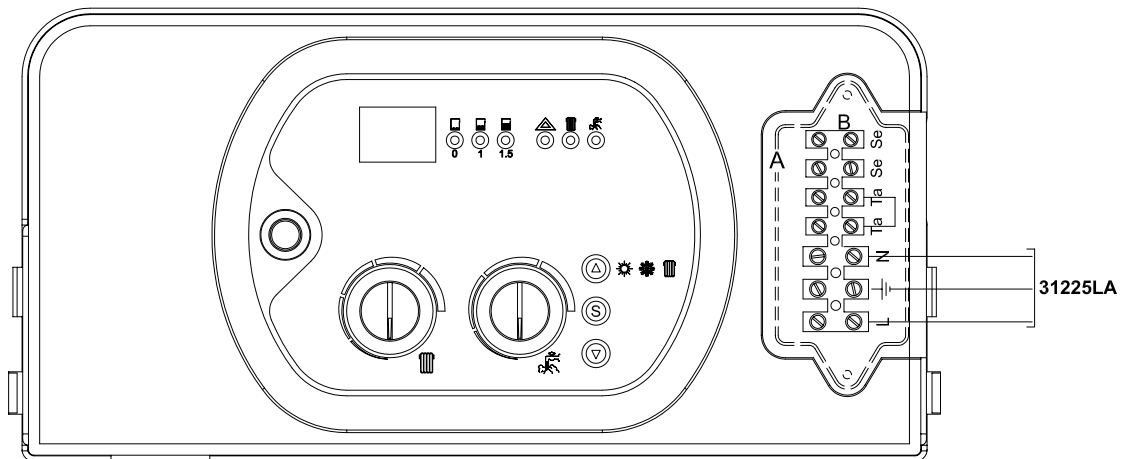

Pos.	Code	Description:	U.M.	Qt.
		Description: Wall hung boiler - with D.H.W. storage cylinder spare parts ELECTRIC SYSTEM		
		Object / model: mod. RBA 24 E <i>room sealed - electronic ignition</i>		
		Date: 15.09.2004	A992A411B351	methane
		Scale: --	A992B411B351	L.P.G.
		Department: tecnico		
		Designed by:		heavy oil
		Controlled by:		
		Approved by:	Sheet no.:	B0358_AE1

ALL DESCRIPTIONS AND ILLUSTRATIONS CONTAINED IN THIS LEAFLET HAVE BEEN CAREFULLY PREPARED BUT WE RESERVE THE RIGHT TO MAKE CHANGES AND IMPROVEMENTS IN OUR PRODUCTS WHICH MAY AFFECT THE ACCURACY OF THE INFORMATION CONTAINED IN THIS LEAFLET, E + OE ALL RIGHTS RESERVED. NO PART OF THIS DOCUMENT MAY BE REPRODUCED, STORED IN STORAGE SYSTEMS OR TRANSMITTED IN ANY FORM OR BY ANY MEANS, WHETHER ELECTRONIC, MECHANICAL, PHOTOCOPIING, RECORDING OR OTHERWISE, WITHOUT THE MANUFACTURER'S PRIOR AUTHORISATION IN WRITING.