

Rev.	Description	Date
------	-------------	------

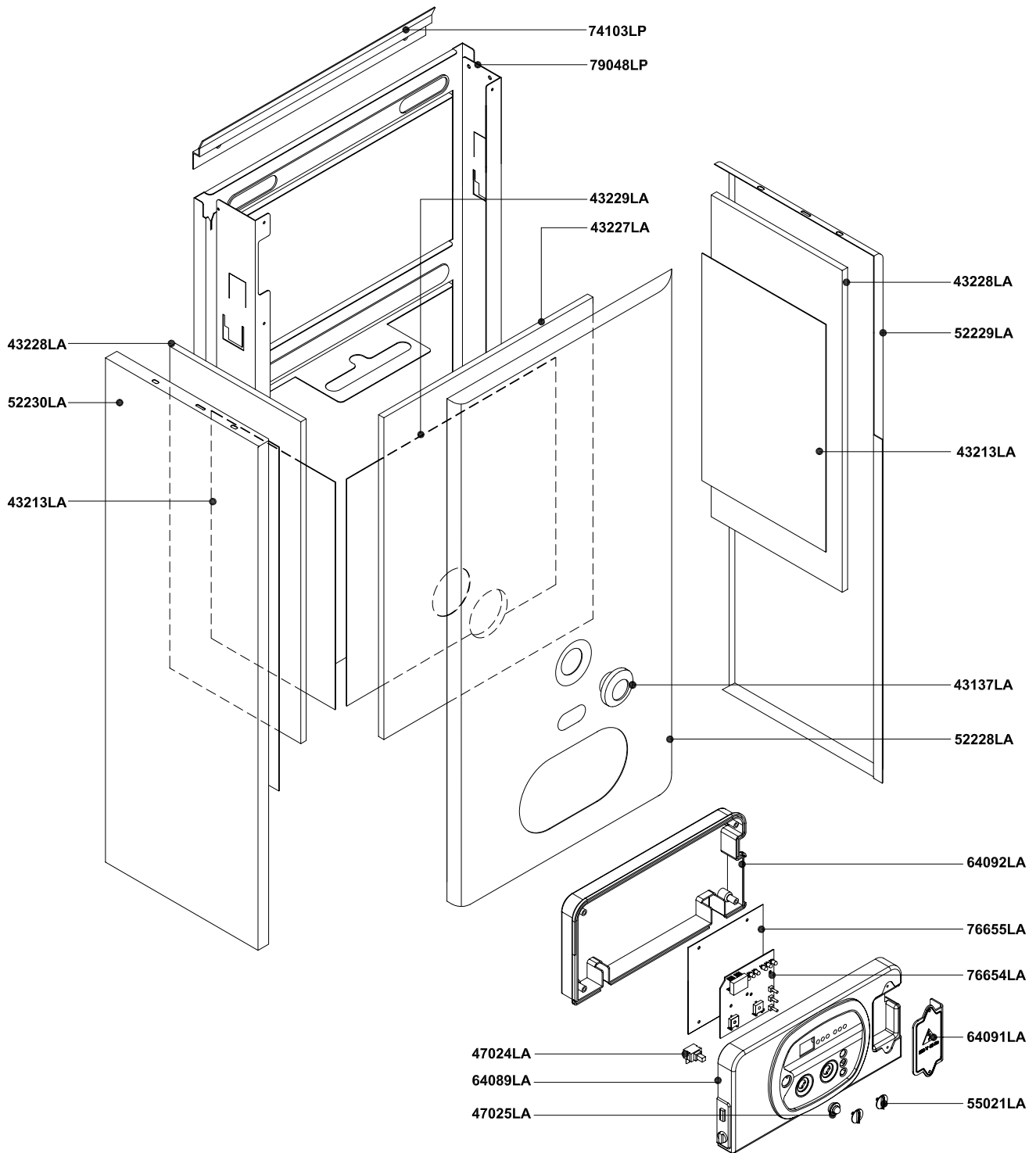

Pos.	Code	Description:	U.M.	Qt.
		Description:	Date: 10.01.2005	A991A232A301 methane
		Wall hung Condensing boiler - Spare parts	Scale: —	A991B232A301 L.P.G.
		FRAME and CASING COMPONENTS	Department: tecnico	
		Object / model:	Designed by:	heavy oil
		mod. RHR 28	Controlled by:	
		Room sealed - electronic ignition	Approved by:	Sheet no.: B0403_AE1
<small>ALL DESCRIPTIONS AND ILLUSTRATIONS CONTAINED IN THIS LEAFLET HAVE BEEN CAREFULLY PREPARED BUT WE RESERVE THE RIGHT TO MAKE CHANGES AND IMPROVEMENTS IN OUR PRODUCTS WHICH MAY AFFECT THE ACCURACY OF THE INFORMATION CONTAINED IN THIS LEAFLET, E + OE ALL RIGHTS RESERVED. NO PART OF THIS DOCUMENT MAY BE REPRODUCED, SAVED IN STORAGE SYSTEMS OR TRANSMITTED IN ANY FORM OR BY ANY MEANS, WHETHER ELECTRONIC, MECHANICAL, PHOTOCOPIING, RECORDING OR OTHERS, WITHOUT THE MANUFACTURERS PRIOR AUTHORISATION IN WRITING.</small>				

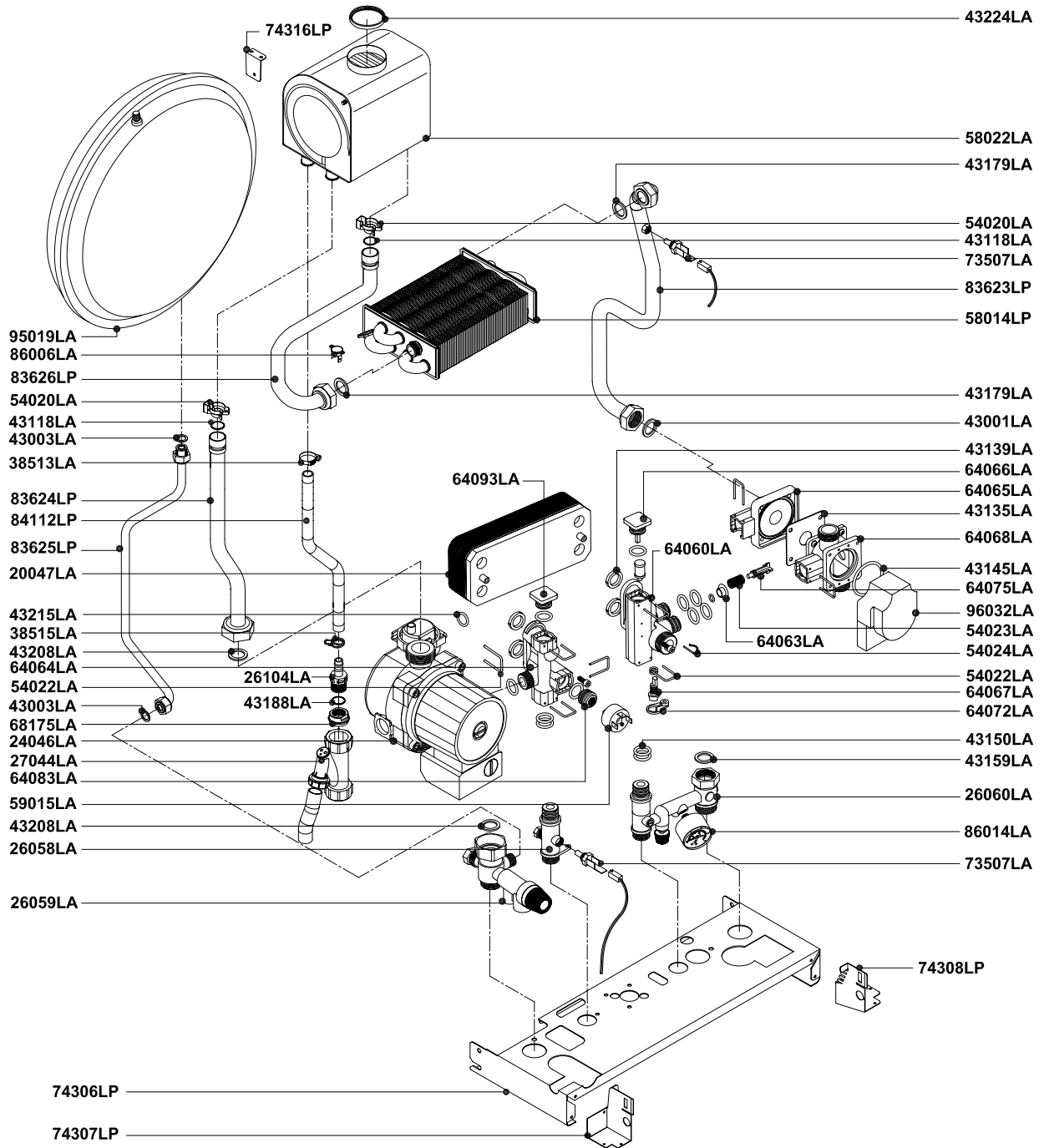



Pos.	Code	Description:	U.M.	Qt.
		Description:		
		Wall hung Condensing boiler - Spare parts		
		HYDRAULIC SYSTEM		
		Object / model:		
		mod. RHR 28		
		Room sealed - electronic ignition		
		Date: 10.01.2005	A991A232A301	methane
		Scale: —	A991B232A301	L.P.G.
		Department: tecnico		
		Designed by:		heavy oil
		Controlled by:		
		Approved by:	Sheet no.:	B0404_AE1

ALL DESCRIPTIONS AND ILLUSTRATIONS CONTAINED IN THIS LEAFLET HAVE BEEN CAREFULLY PREPARED BUT WE RESERVE THE RIGHT TO MAKE CHANGES AND IMPROVEMENTS IN OUR PRODUCTS WHICH MAY AFFECT THE ACCURACY OF THE INFORMATION CONTAINED IN THIS LEAFLET, E + OE ALL RIGHTS RESERVED. NO PART OF THIS DOCUMENT MAY BE REPRODUCED, SAID IN STORAGE SYSTEMS OR TRANSMITTED IN ANY FORM OR BY ANY MEANS, WHETHER ELECTRONIC, MECHANICAL, PHOTOCOPIING, RECORDING OR OTHERS, WITHOUT THE MANUFACTURERS PRIOR AUTHORISATION IN WRITING.

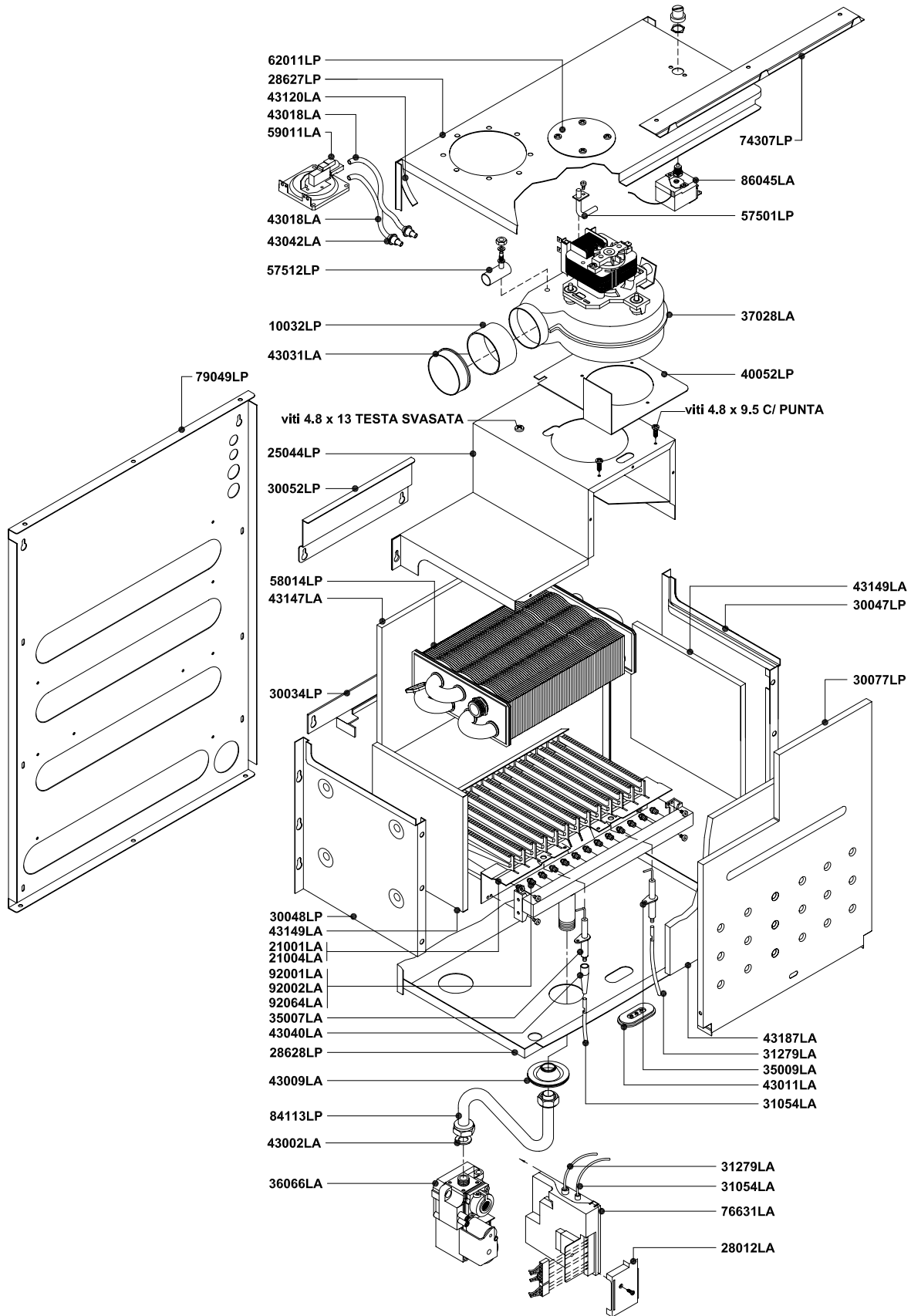

Pos.	Code	Description:	U.M.	Qt.
		Description:	Date: 10.01.2005	A991A232A301 methane
		Wall hung Condensing boiler - Spare parts	Scale: —	A991B232A301 L.P.G.
		THERMAL SYSTEM (ROOM SEALED - ELECT. IGNITION)	Department: tecnico	
		Object / model:	Designed by:	heavy oil
		mod. RHR 28	Controlled by:	
		Room sealed - electronic ignition	Approved by:	Sheet no.: B0405_AE1
<small>ALL DESCRIPTIONS AND ILLUSTRATIONS CONTAINED IN THIS LEAFLET HAVE BEEN CAREFULLY PREPARED BUT WE RESERVE THE RIGHT TO MAKE CHANGES AND IMPROVEMENTS IN OUR PRODUCTS WHICH MAY AFFECT THE ACCURACY OF THE INFORMATION CONTAINED IN THIS LEAFLET, E + OE ALL RIGHTS RESERVED. NO PART OF THIS DOCUMENT MAY BE REPRODUCED, SAID IN STORAGE SYSTEMS OR TRANSMITTED IN ANY FORM OR BY ANY MEANS, WHETHER ELECTRONIC, MECHANICAL, PHOTOCOPIING, RECORDING OR OTHERS, WITHOUT THE MANUFACTURER'S PRIOR AUTHORISATION IN WRITING.</small>				



RADIANT BRUCIATORI S.p.A.

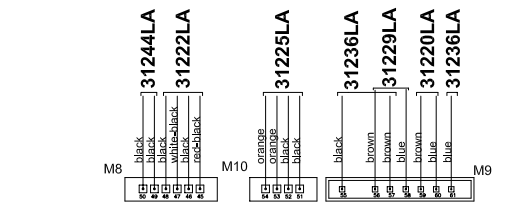

MAIN PRINTED CIRC. BOARD CVI-M SM 20015 COD. 76655LA

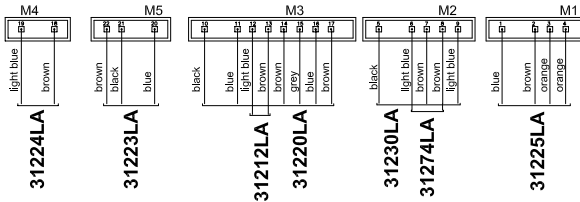
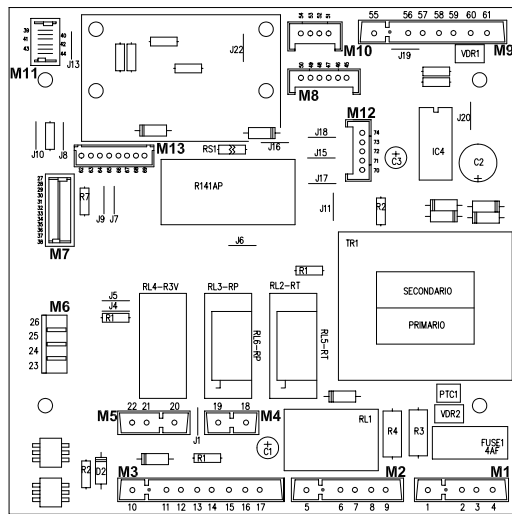

DISPLAY DIGITAL BOARD 2000 SKO6206 76654LA

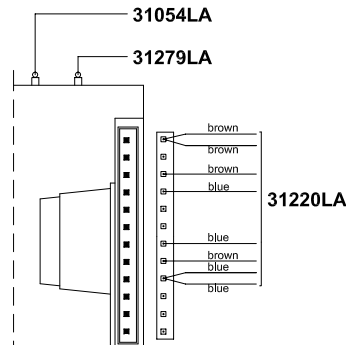
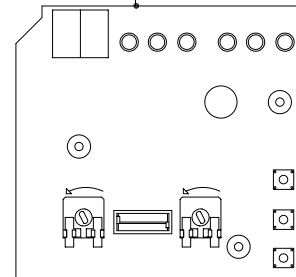

ELECTRONIC IGNITION BOARD S4565QM1012 code 76631LA

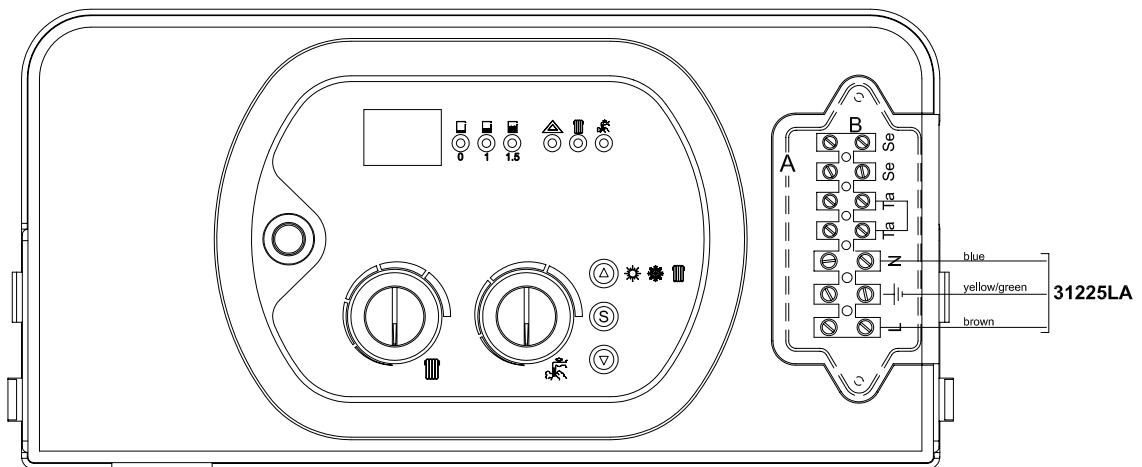

Pos.	Code	Description:	U.M.	Qt.
		Description: Wall hung Condensing boiler - Spare parts ELECTRIC SYSTEM (ROOM SEALED- ELECTR. IGNITION)		
		Object / model: mod. RHR 28 Room sealed - electronic ignition		
		Date: 10.01.2005	A991A232A301	methane
		Scale: --	A991B232A301	L.P.G.
		Department: tecnico		
		Designed by:		heavy oil
		Controlled by:		
		Approved by:	Sheet no.:	B0406_AE1

ALL DESCRIPTIONS AND ILLUSTRATIONS CONTAINED IN THIS LEAFLET HAVE BEEN CAREFULLY PREPARED BUT WE RESERVE THE RIGHT TO MAKE CHANGES AND IMPROVEMENTS IN OUR PRODUCTS WHICH MAY AFFECT THE ACCURACY OF THE INFORMATION CONTAINED IN THIS LEAFLET, E + OE ALL RIGHTS RESERVED. NO PART OF THIS DOCUMENT MAY BE REPRODUCED, SAID IN STORAGE SYSTEMS OR TRANSMITTED IN ANY FORM OR BY ANY MEANS, WHETHER ELECTRONIC, MECHANICAL, PHOTOCOPIING, RECORDING OR OTHERS, WITHOUT THE MANUFACTURER'S PRIOR AUTHORIZATION IN WRITING.