

Rev.	Description	Date
------	-------------	------

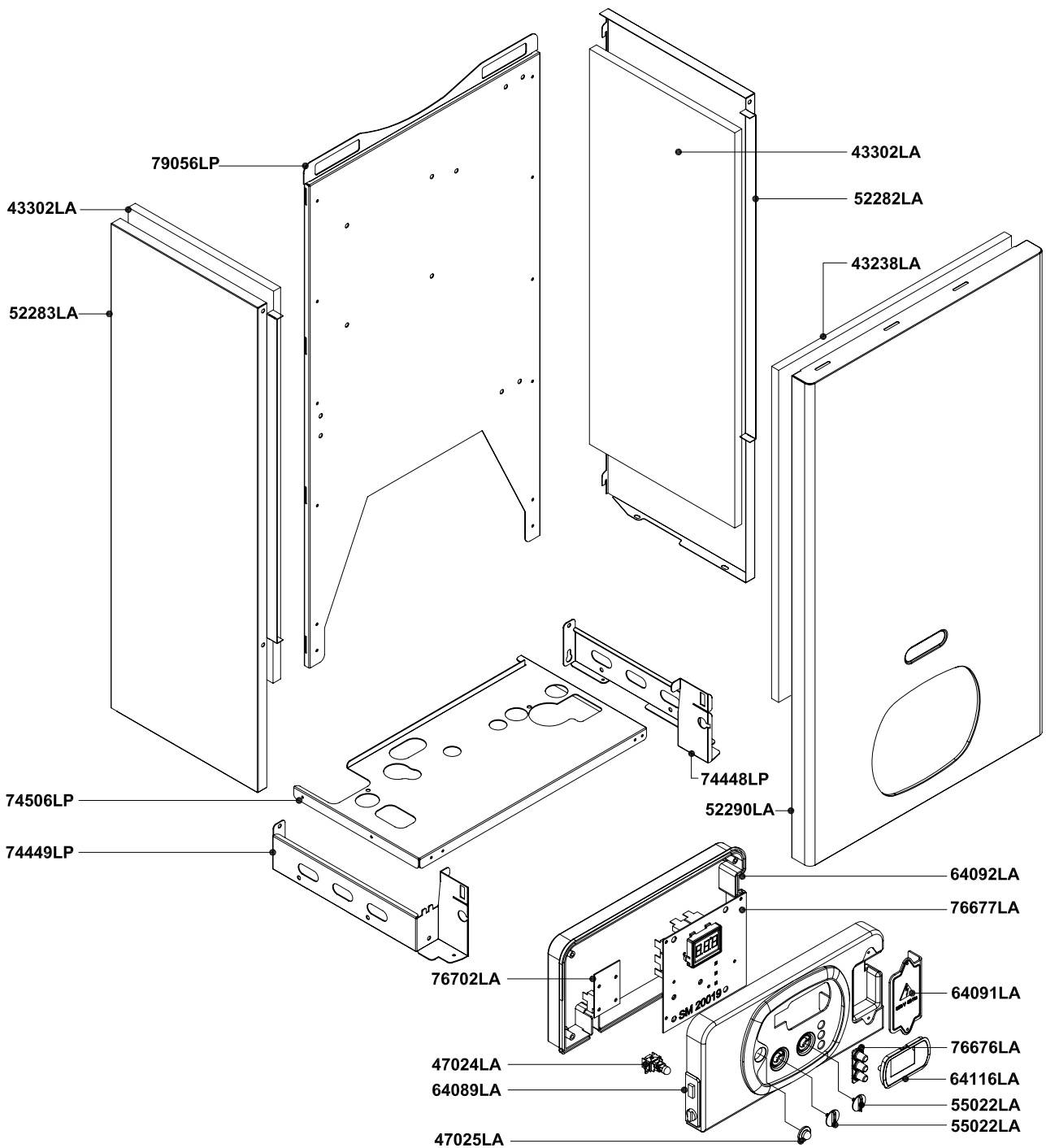

Pos.	Code	Description:	U.M.	Qt.
		Description: Wall hung Condensing boiler - Spare parts FRAME and CASING COMPONENTS		
		Object / model: mod. RK 29/B Only Heating		
		Date: 21.01.07	A991A732A301	methane
		Scale: —	A991B732A301	L.P.G.
		Department: tecnico		
		Designed by:		heavy oil
		Controlled by:		
		Approved by:	Sheet no.:	B0591_AE1
<small>ALL DESCRIPTIONS AND ILLUSTRATIONS CONTAINED IN THIS LEAFLET HAVE BEEN CAREFULLY PREPARED BUT WE RESERVE THE RIGHT TO MAKE CHANGES AND IMPROVEMENTS IN OUR PRODUCTS WHICH MAY AFFECT THE ACCURACY OF THE INFORMATION CONTAINED IN THIS LEAFLET, E + OE ALL RIGHTS RESERVED. NO PART OF THIS DOCUMENT MAY BE REPRODUCED, SAVED IN STORAGE SYSTEMS OR TRANSMITTED IN ANY FORM OR BY ANY MEANS, WHETHER ELECTRONIC, MECHANICAL, PHOTOCOPIING, RECORDING OR OTHERS, WITHOUT THE MANUFACTURERS PRIOR AUTHORISATION IN WRITING.</small>				



RADIANT BRUCIATORI S.p.A.

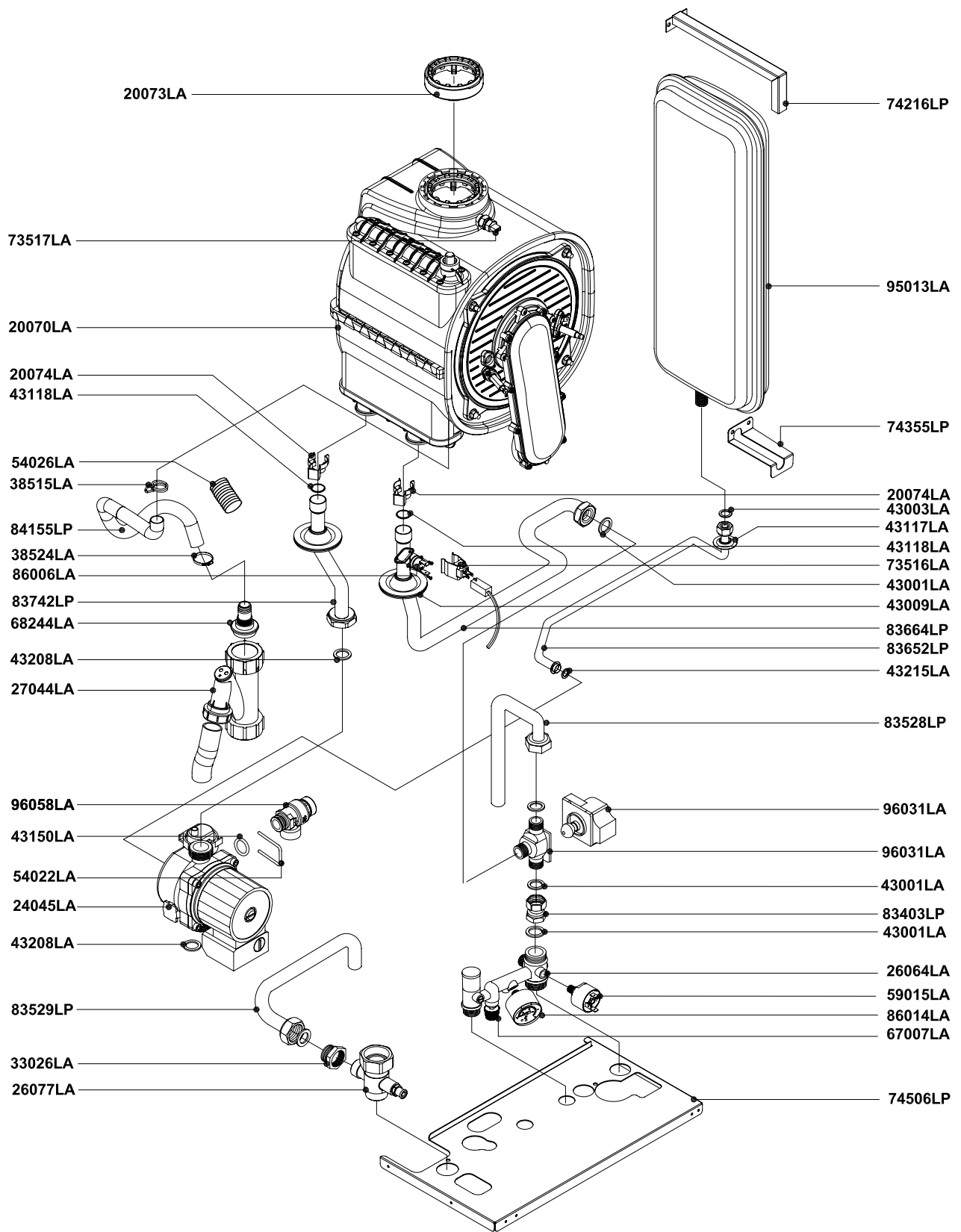

Pos.	Code	Description:	U.M.	Qt.
		Description:	Date: 13.01.07	A991A732A301 methane
		Wall hung Condensing boiler - Spare parts	Scale: —	A991B732A301 L.P.G.
		HYDRAULIC SYSTEM	Department: tecnico	
		Object / model:	Designed by:	heavy oil
		mod. RK 29/B	Controlled by:	
		Only Heating	Approved by:	Sheet no.: B0592_AE1
<small>ALL DESCRIPTIONS AND ILLUSTRATIONS CONTAINED IN THIS LEAFLET HAVE BEEN CAREFULLY PREPARED BUT WE RESERVE THE RIGHT TO MAKE CHANGES AND IMPROVEMENTS IN OUR PRODUCTS WHICH MAY AFFECT THE ACCURACY OF THE INFORMATION CONTAINED IN THIS LEAFLET, E + OE ALL RIGHTS RESERVED. NO PART OF THIS DOCUMENT MAY BE REPRODUCED, SAVED IN STORAGE SYSTEMS OR TRANSMITTED IN ANY FORM OR BY ANY MEANS, WHETHER ELECTRONIC, MECHANICAL, PHOTOCOPIING, RECORDING OR OTHERS, WITHOUT THE MANUFACTURERS PRIOR AUTHORISATION IN WRITING.</small>				



RADIANT BRUCIATORI S.p.A.

Rev.

Description

Date

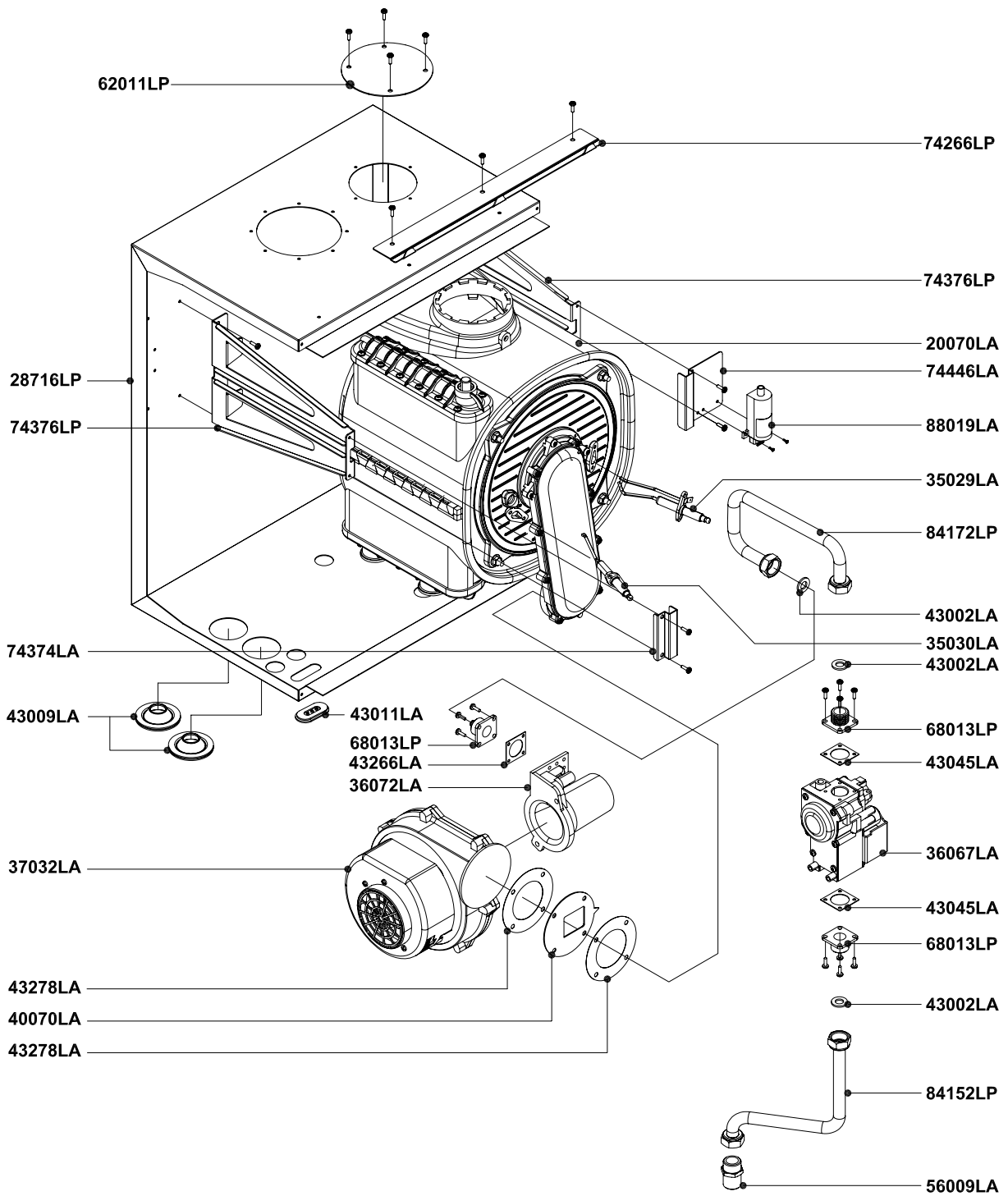

Pos.	Code	Description:	U.M.	Qt.
		Description:		
		Wall hung Condensing boiler - Spare parts		
		THERMAL SYSTEM		
		Object / model:		
		mod. RK 29/B		
		Only Heating		
		Date: 17.01.07	A991A732A301	methane
		Scale: —	A991B732A301	L.P.G.
		Department: tecnico		
		Designed by:		heavy oil
		Controlled by:		
		Approved by:	Sheet no.:	B0593_AE1

ALL DESCRIPTIONS AND ILLUSTRATIONS CONTAINED IN THIS LEAFLET HAVE BEEN CAREFULLY PREPARED BUT WE RESERVE THE RIGHT TO MAKE CHANGES AND IMPROVEMENTS IN OUR PRODUCTS WHICH MAY AFFECT THE ACCURACY OF THE INFORMATION CONTAINED IN THIS LEAFLET, E + OE ALL RIGHTS RESERVED. NO PART OF THIS DOCUMENT MAY BE REPRODUCED, SAID IN STORAGE SYSTEMS OR TRANSMITTED IN ANY FORM OR BY ANY MEANS, WHETHER ELECTRONIC, MECHANICAL, PHOTOCOPIING, RECORDING OR OTHERS, WITHOUT THE MANUFACTURER'S PRIOR AUTHORISATION IN WRITING.

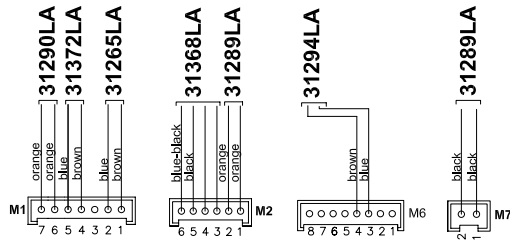

PRINTED CIRCUIT BOARD - SM 20019
DIGITECH code 76677LA

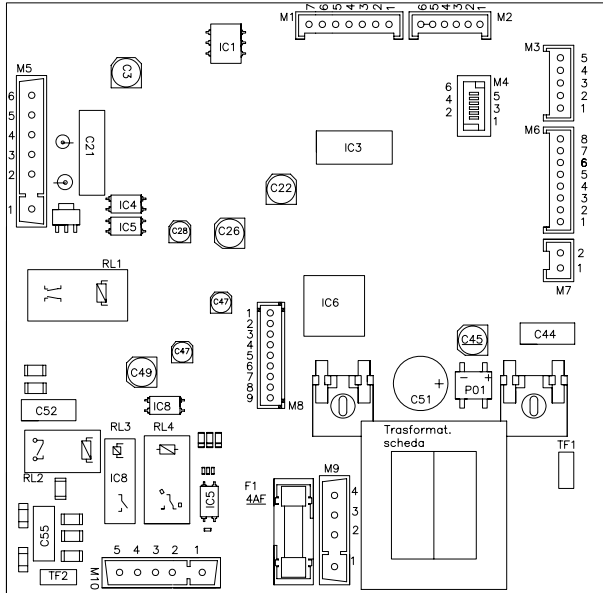

31331LA

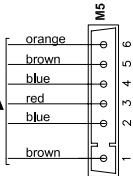

PRINTED CIRCUIT BOARD
KOND DT - SK11003
code 76702LA

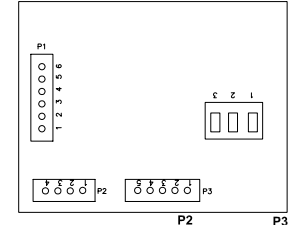

31330LA



31330LA

31372LA

31326LA

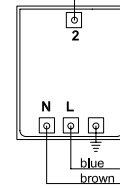

31331LA

IGNITION TRANSFORMER 25HZ
AC1 230VA code 88019LA

31327LA

31288LA

31331LA

31289LA

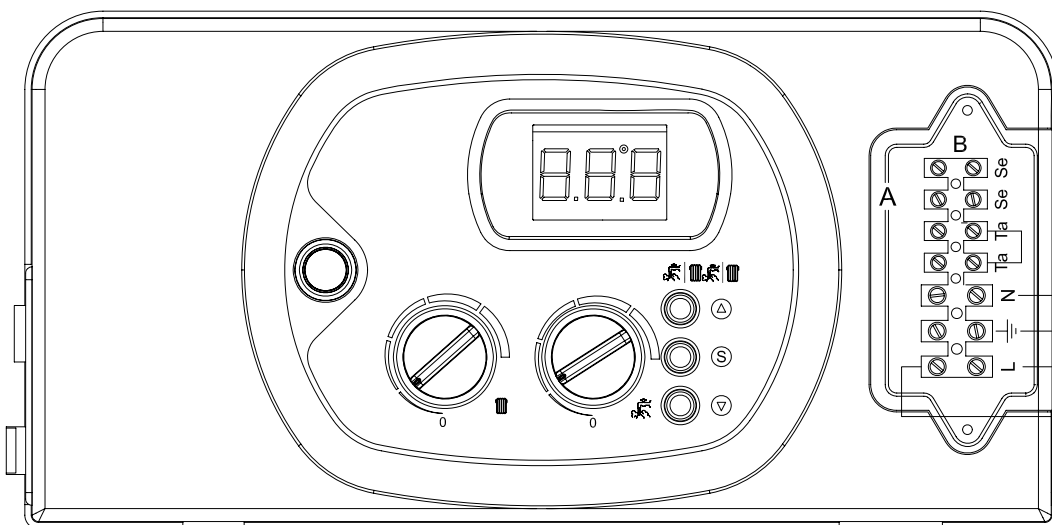

31289LA

31331LA

Pos.	Code	Description:	U.M.	Qt.
		Description: Wall hung Condensing boiler - Spare parts ELECTRIC SYSTEM		
		Object / model: mod. RK 29/B Only Heating		
		Date: 17.01.07	A991A732A301	methane
		Scale: —	A991B732A301	L.P.G.
		Department: tecnico		
		Designed by:		heavy oil
		Controlled by:		
		Approved by:	Sheet no.:	B0594_AE1

ALL DESCRIPTIONS AND ILLUSTRATIONS CONTAINED IN THIS LEAFLET HAVE BEEN CAREFULLY PREPARED BUT WE RESERVE THE RIGHT TO MAKE CHANGES AND IMPROVEMENTS IN OUR PRODUCTS WHICH MAY AFFECT THE ACCURACY OF THE INFORMATION CONTAINED IN THIS LEAFLET, E + OE ALL RIGHTS RESERVED. NO PART OF THIS DOCUMENT MAY BE REPRODUCED, SAVED IN STORAGE SYSTEMS OR TRANSMITTED IN ANY FORM OR BY ANY MEANS, WHETHER ELECTRONIC, MECHANICAL, PHOTOCOPIING, RECORDING OR OTHERWISE, WITHOUT THE MANUFACTURER'S PRIOR AUTHORISATION IN WRITING.