

Rev.	Description	Date
------	-------------	------

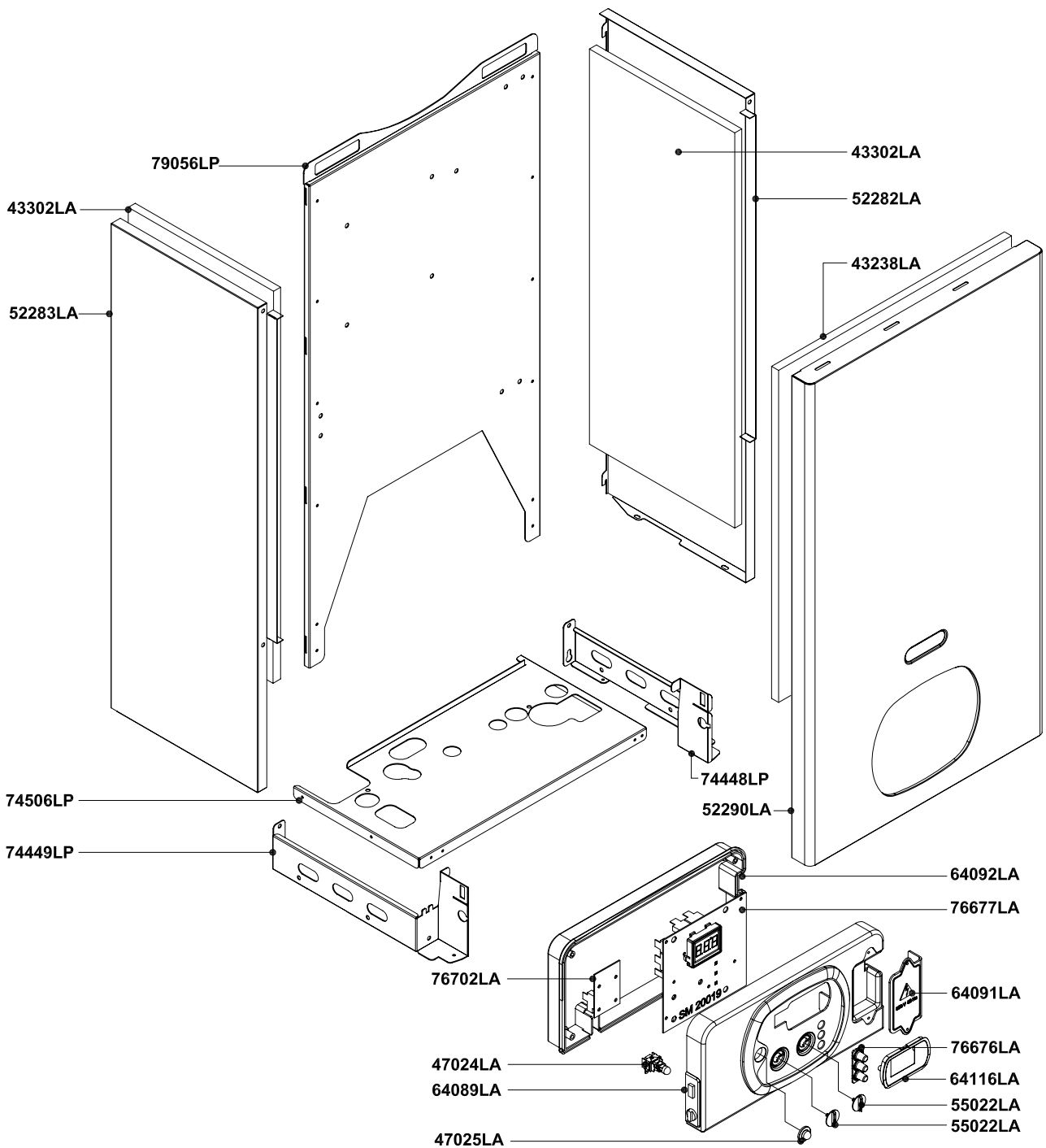

Pos.	Code	Description:	U.M.	Qt.
		Description:	Date: 21.01.07	A991A732A501 methane
		<b>Wall hung Condensing boiler - Spare parts</b>	Scale: —	A991B732A501 L.P.G.
		<b>FRAME and CASING COMPONENTS</b>	Department: tecnico	
		Object / model:	Designed by:	heavy oil
		mod. <b>RK 34/B</b>	Controlled by:	
		Only Heating	Approved by:	Sheet no.: <b>B0595_AE1</b>
<small>ALL DESCRIPTIONS AND ILLUSTRATIONS CONTAINED IN THIS LEAFLET HAVE BEEN CAREFULLY PREPARED BUT WE RESERVE THE RIGHT TO MAKE CHANGES AND IMPROVEMENTS IN OUR PRODUCTS WHICH MAY AFFECT THE ACCURACY OF THE INFORMATION CONTAINED IN THIS LEAFLET, E + OE ALL RIGHTS RESERVED. NO PART OF THIS DOCUMENT MAY BE REPRODUCED, SAVED IN STORAGE SYSTEMS OR TRANSMITTED IN ANY FORM OR BY ANY MEANS, WHETHER ELECTRONIC, MECHANICAL, PHOTOCOPIING, RECORDING OR OTHERS, WITHOUT THE MANUFACTURERS PRIOR AUTHORISATION IN WRITING.</small>				

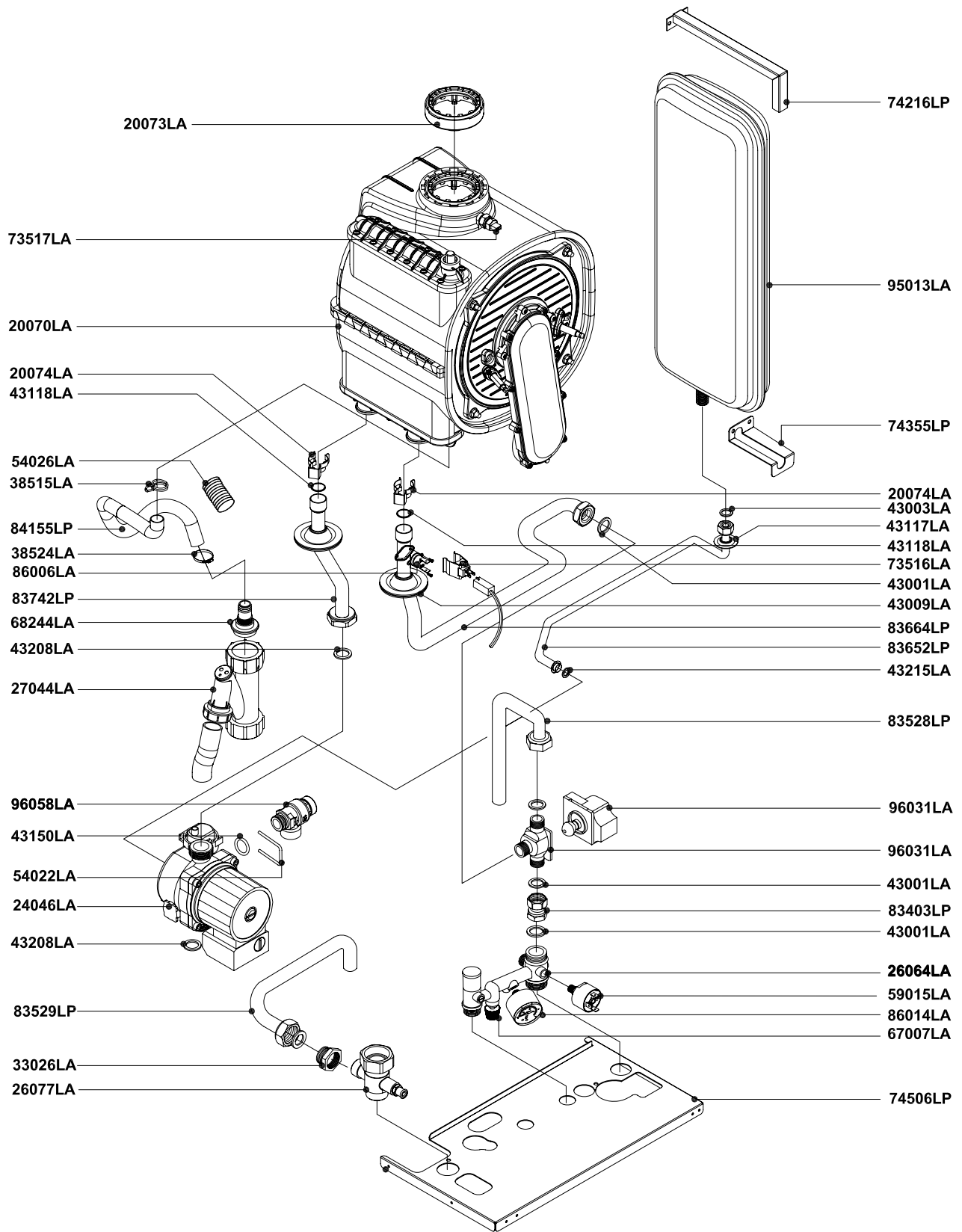



Pos.	Code	Description:	U.M.	Qt.
		Description:	Date: 13.01.07	A991A732A501 methane
		<b>Wall hung Condensing boiler - Spare parts</b>	Scale: —	A991B732A501 L.P.G.
		<b>HYDRAULIC SYSTEM</b>	Department: tecnico	
		Object / model:	Designed by:	heavy oil
		mod. <b>RK 34/B</b>	Controlled by:	
		Only Heating	Approved by:	Sheet no.: <b>B0596_AE1</b>
<small>ALL DESCRIPTIONS AND ILLUSTRATIONS CONTAINED IN THIS LEAFLET HAVE BEEN CAREFULLY PREPARED BUT WE RESERVE THE RIGHT TO MAKE CHANGES AND IMPROVEMENTS IN OUR PRODUCTS WHICH MAY AFFECT THE ACCURACY OF THE INFORMATION CONTAINED IN THIS LEAFLET, E + OE ALL RIGHTS RESERVED. NO PART OF THIS DOCUMENT MAY BE REPRODUCED, SAVED IN STORAGE SYSTEMS OR TRANSMITTED IN ANY FORM OR BY ANY MEANS, WHETHER ELECTRONIC, MECHANICAL, PHOTOCOPIING, RECORDING OR OTHERS, WITHOUT THE MANUFACTURERS PRIOR AUTHORISATION IN WRITING.</small>				



RADIANT BRUCIATORI S.p.A.

Rev.

Description

Date

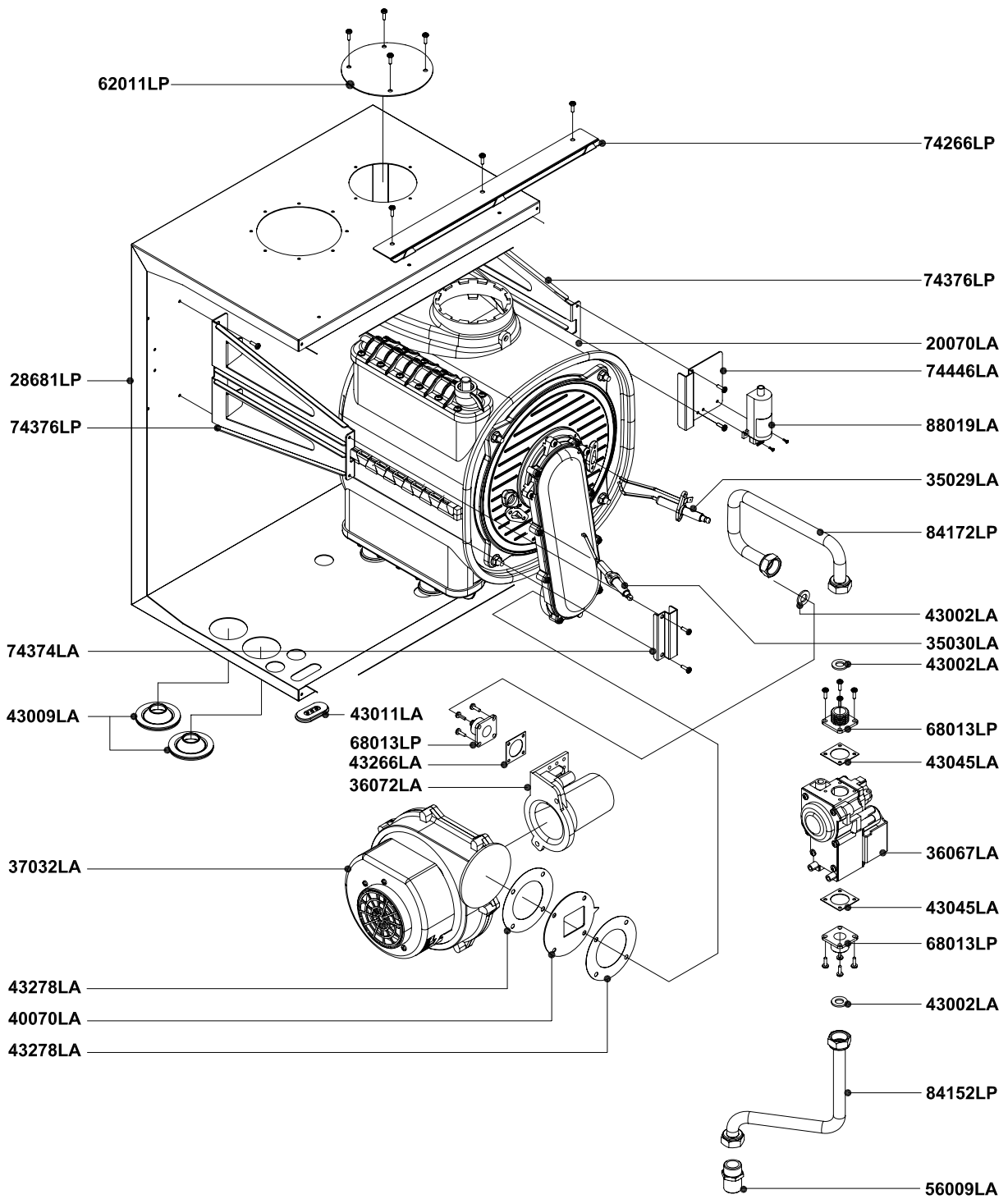

Pos.	Code	Description:	U.M.	Qt.
		Description:		
		<b>Wall hung Condensing boiler - Spare parts</b>		
		<b>THERMAL SYSTEM</b>		
		Object / model:		
		mod. <b>RK 34/B</b>		
		Only Heating		
		Date: 17.01.07	A991A732A501	methane
		Scale: —	A991B732A501	L.P.G.
		Department: tecnico		
		Designed by:		heavy oil
		Controlled by:		
		Approved by:	Sheet no.:	<b>B0597_AE1</b>

ALL DESCRIPTIONS AND ILLUSTRATIONS CONTAINED IN THIS LEAFLET HAVE BEEN CAREFULLY PREPARED BUT WE RESERVE THE RIGHT TO MAKE CHANGES AND IMPROVEMENTS IN OUR PRODUCTS WHICH MAY AFFECT THE ACCURACY OF THE INFORMATION CONTAINED IN THIS LEAFLET, E + OE ALL RIGHTS RESERVED. NO PART OF THIS DOCUMENT MAY BE REPRODUCED, SAVED IN STORAGE SYSTEMS OR TRANSMITTED IN ANY FORM OR BY ANY MEANS, WHETHER ELECTRONIC, MECHANICAL, PHOTOCOPIING, RECORDING OR OTHERWISE, WITHOUT THE MANUFACTURER'S PRIOR AUTHORISATION IN WRITING.

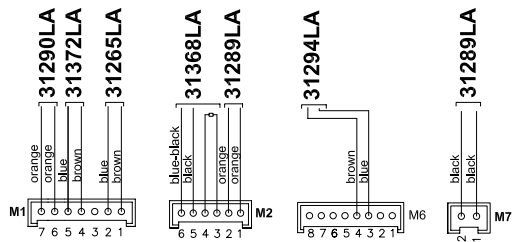

**PRITED CIRCUIT BOARD - SM 20019**  
DIGITECH code 76677LA

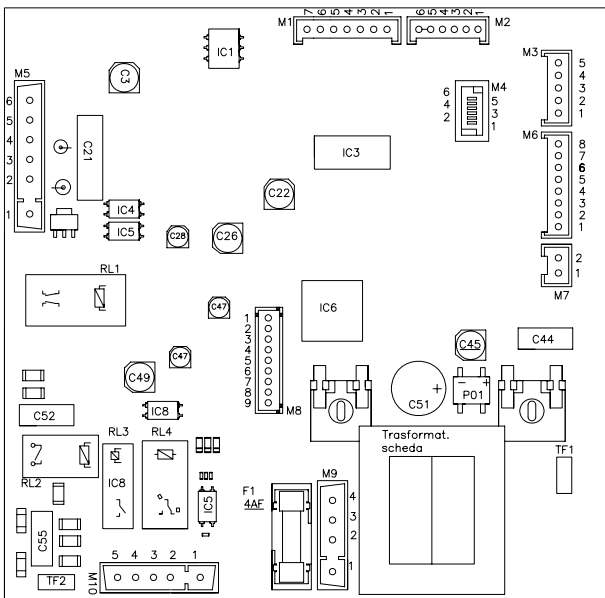

31331LA

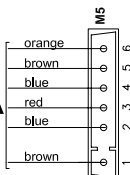

**PRINTED CIRCUIT BOARD**  
KOND DT - SK11003  
code 76702LA

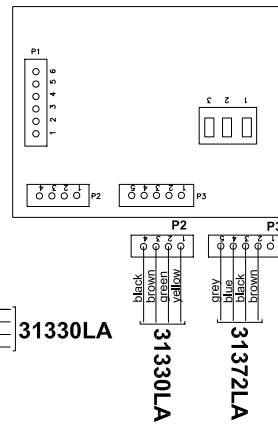

31330LA

31330LA

31372LA



31291LA

31326LA

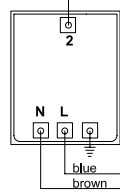

31331LA

**IGNITION TRANSFORMER 25HZ**  
AC1 230VA code 88019LA

31327LA

31288LA

31331LA

31289LA

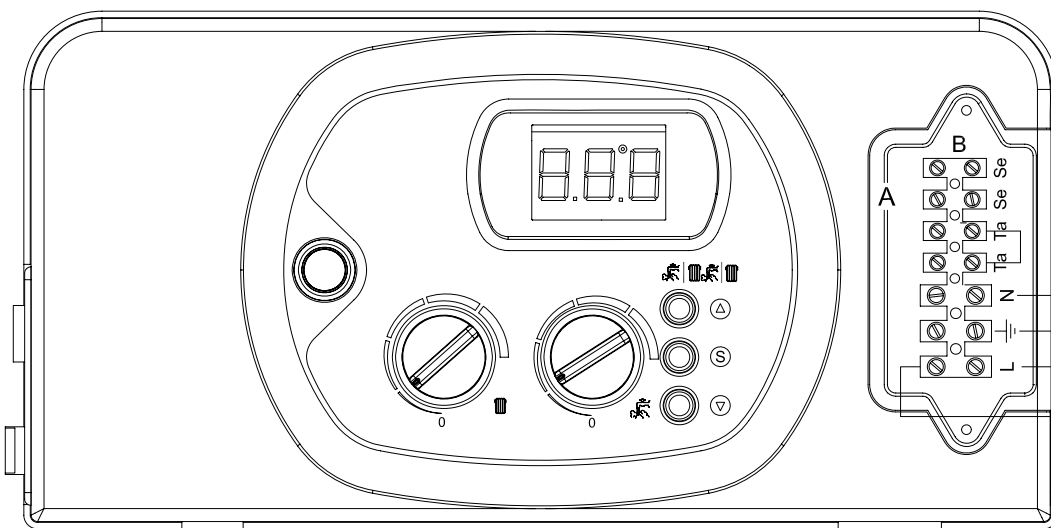

31289LA

31331LA

 RADIANT BRUCIATORI S.p.A.	Pos.	Code	Description:	U.M.	Qt.	
			Description:			
			<b>Wall hung Condensing boiler - Spare parts</b>		A991A732A501	methane
			<b>ELECTRIC SYSTEM</b>		A991B732A501	L.P.G.
			Object / model:			
			mod. <b>RK 34/B</b>			heavy oil
		Only Heating				
			Date: 17.01.07			
			Scale: —			
			Department: tecnico			
			Designed by:			
			Controlled by:			
			Approved by:			
				Sheet no.:	<b>B0598_AE1</b>	

ALL DESCRIPTIONS AND ILLUSTRATIONS CONTAINED IN THIS LEAFLET HAVE BEEN CAREFULLY PREPARED BUT WE RESERVE THE RIGHT TO MAKE CHANGES AND IMPROVEMENTS IN OUR PRODUCTS WHICH MAY AFFECT THE ACCURACY OF THE INFORMATION CONTAINED IN THIS LEAFLET. E + OE ALL RIGHTS RESERVED. NO PART OF THIS DOCUMENT MAY BE REPRODUCED, STORED IN RETRIEVAL SYSTEMS OR TRANSMITTED IN ANY FORM OR BY ANY MEANS, WHETHER ELECTRONIC, MECHANICAL, PHOTOCOPIING, RECORDING OR OTHERWISE, WITHOUT THE MANUFACTURER'S PRIOR AUTHORIZATION IN WRITING.